

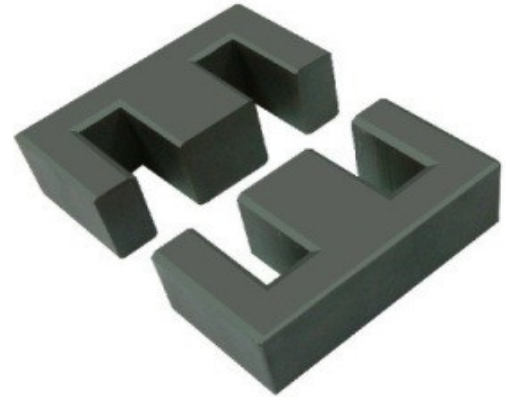

Appearance & Shape: To be free from any defect such as flow, burrs, unevenness etc; as per IEC standards

Effective parameters irrespective of material grade (per set)

Parameter	Value	Unit
Effective Length (L_e)	43.5	mm
Effective Area (A_e)	21.6	mm ²
Effective Area (A_{Min})	20.2	mm ²
Effective Volume (V_e)	937	mm ³
Approx. Weight (without gap)	4.8	g/set



EE2105 Un-gapped (OL)

Test Conditions: 1kHz/1mT/CFR COIL,N=100/25°C

Material Grade	Initial Permeability (μ_{iac})	AL Value (nH)/Set	P_v (W/set)	Ordering code
CF292	1800 ±20%	800 +30%/-20%	≤0.11 (100mT,100kHz,100°C)	CF292 EE2105 OL
CF139	2100 ±20%	950 +30%/-20%	≤0.09 (100mT,100kHz,100°C)	CF139 EE2105 OL
CF297	2300 ±20%	1050 +30%/-20%	≤0.075 (100mT,100kHz,100°C)	CF297 EE2105 OL
CF124	2500 ±20%	1150 +30%/-20%	≤0.14 (200mT,25kHz,100°C)	CF124 EE2105 OL

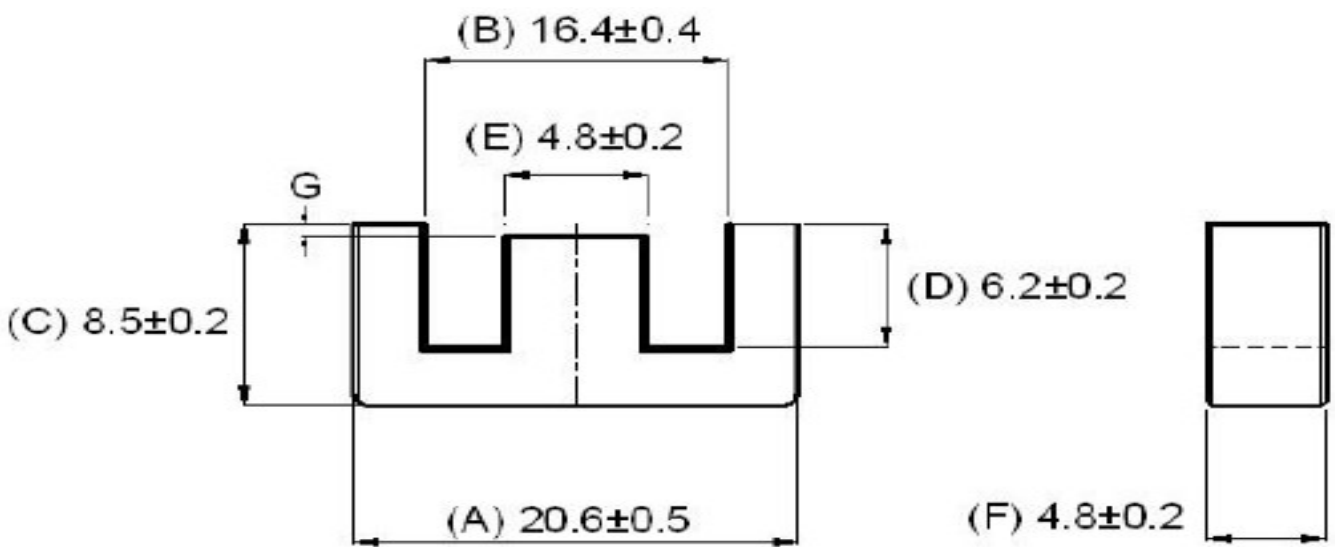

Remarks: Value of "G" is Zero (0) for Un-Gapped Cores, for Gapped Cores the value of "G" varies as per the Gap/AL value

For general terms and conditions please visit

http://www.cosmoferrites.com/Downloads/Downloads/bcb70e7c-ae33-40ec-a881-0d5120db57b6_GTC.pdf

Regd. Office & Works: Jabli, Distt. Solan, Himachal Pradesh – 173 209 (India)

E-mail: sales@cosmoferrites.com