

**PRODUCT DATA SHEET****Appearance & Shape:** To be free from any defect such as flow, burrs, unevenness etc; as per IEC standards**Effective parameters irrespective of material grade (per piece)**

Parameter	Value	Unit
Effective Length (L_e)	20.7	mm
Effective Area (A_e)	13.8	mm ²
Effective Area (A_{Min})	13.8	mm ²
Effective Volume (V_e)	286	mm ³
Approx. Weight (without gap)	1.10	g/piece

**T0906 Coated (Green)****Test Conditions:** 10kHz/150mV/CFR COIL,N=01/ L_0 =Zero/25°C

Material Grade	Initial Permeability (μ_{iac})	AL Value (nH)	D. Strength (kV)	Ordering code
CF195	5000 \pm 20%	4200 +30%/-20%	\geq 1.0	CF195 T0906 C
CF190	6000 \pm 20%	5000 +30%/-20%	\geq 1.0	CF190 T0906 C
CF197	7000 \pm 20%	5900 +30%/-20%	\geq 1.0	CF197 T0906 C
CF199	9000 \pm 20%	7500 +30%/-30%	\geq 1.0	CF199 T0906 C

Dimensions Un-Coated Core (in mm)

Dimension	Nominal	Maximum	Minimum
A	9.53	9.83	9.23
B	4.75	4.95	4.55
C	6.0	6.20	5.80

Dimensions Coated Core (in mm)

Dimension	Nominal	Maximum	Minimum
A	-	10.35	-
B	-	-	4.0
C	-	6.70	-

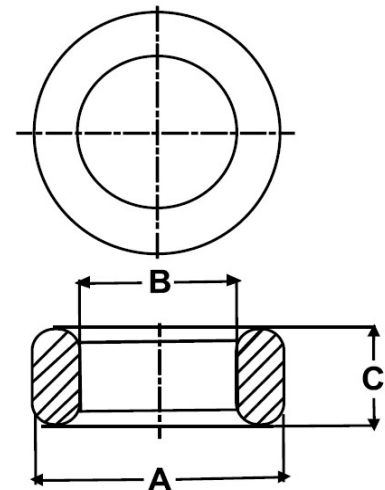

- Ferrite material for the product is in compliance with RoHS directive 2011/65/EU
- Epoxy Coating is UL Approved, UL file number E483791
- Coating material for the product is in compliance with RoHS directive 2011/65/EU

For general terms and conditions please visit

http://www.cosmoferrites.com/Downloads/Downloads/bcb70e7c-ae33-40ec-a881-0d5120db57b6_GTC.pdf**Regd. Office & Works: Jabli, Distt. Solan, Himachal Pradesh – 173 209 (India)****E-mail: sales@cosmoferrites.com**