

**PRODUCT DATA SHEET****Appearance & Shape:** To be free from any defect such as flow, burrs, unevenness etc; as per IEC standards**Effective parameters irrespective of material grade (per piece)**

Parameter	Value	Unit
Effective Length ( $L_e$ )	54.15	mm
Effective Area ( $A_e$ )	26.17	mm <sup>2</sup>
Effective Area ( $A_{Min}$ )	26.17	mm <sup>2</sup>
Effective Volume ( $V_e$ )	1417	mm <sup>3</sup>
Approx. Weight (without gap)	7.1	g/piece

**T2206 Coated (Green)****Test Conditions:** 10kHz/150mV/CFR COIL,N=01/ $L_0$ =Zero/25°C

Material Grade	Initial Permeability ( $\mu_{iac}$ )	AL Value (nH)	D. Strength (kV)	Ordering code
CF195	5000 ±20%	3000 +30%/-20%	≥2.0	CF195 T2206 C
CF190	6000 ±20%	3600 +30%/-20%	≥2.0	CF190 T2206 C
CF197	7000 ±20%	4200 +30%/-20%	≥2.0	CF197 T2206 C
CF199	9000 ±20%	5450 +30%/-30%	≥2.0	CF199 T2206 C

**Dimensions Un-Coated Core (in mm)**

Dimension	Nominal	Maximum	Minimum
A	22.1	22.5	21.7
B	13.7	14.0	13.4
C	6.35	6.65	6.05

**Dimensions Coated Core (in mm)**

Dimension	Nominal	Maximum	Minimum
A	-	23.1	-
B	-	-	12.8
C	-	7.25	-

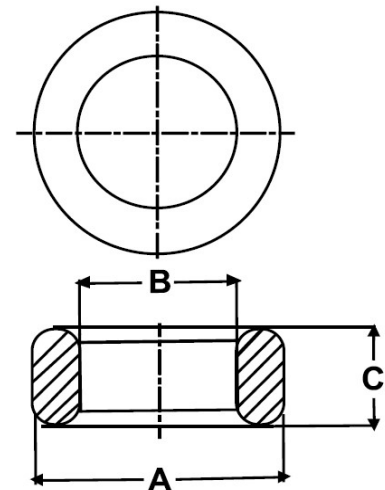

- Ferrite material for the product is in compliance with RoHS directive 2011/65/EU
- Epoxy Coating is UL Approved, UL file number E483791
- Coating material for the product is in compliance with RoHS directive 2011/65/EU

For general terms and conditions please visit

[http://www.cosmoferrites.com/Downloads/Downloads/bcb70e7c-ae33-40ec-a881-0d5120db57b6\\_GTC.pdf](http://www.cosmoferrites.com/Downloads/Downloads/bcb70e7c-ae33-40ec-a881-0d5120db57b6_GTC.pdf)**Regd. Office & Works: Jabli, Distt. Solan, Himachal Pradesh – 173 209 (India)****E-mail: sales@cosmoferrites.com**