

**PRODUCT DATA SHEET****Appearance & Shape:** To be free from any defect such as flow, burrs, unevenness etc; as per IEC standards**Effective parameters irrespective of material grade (per piece)**

Parameter	Value	Unit
Effective Length (L_e)	38.5	mm
Effective Area (A_e)	15.7	mm ²
Effective Area (A_{Min})	15.7	mm ²
Effective Volume (V_e)	603	mm ³
Approx. Weight (without gap)	2.9	g/piece

**T1605 Coated (Green)****Test Conditions:** 10kHz/150mV/CFR COIL,N=01/ L_0 =Zero/25°C

Material Grade	Initial Permeability (μ_{iac})	AL Value (nH)	D. Strength (kV)	Ordering code
CF195	5000 ±20%	2600 +30%/-20%	≥1.5	CF195 T1605 C
CF190	6000 ±20%	3100 +30%/-20%	≥1.5	CF190 T1605 C
CF197	7000 ±20%	3600 +30%/-20%	≥1.5	CF197 T1605 C
CF199	9000 ±20%	4600 +30%/-30%	≥1.5	CF199 T1605 C

Dimensions Un-Coated Core (in mm)

Dimension	Nominal	Maximum	Minimum
A	16.0	16.4	15.6
B	9.6	9.9	9.3
C	5.0	5.2	4.8

Dimensions Coated Core (in mm)

Dimension	Nominal	Maximum	Minimum
A	-	17.0	-
B	-	-	8.7
C	-	5.8	-

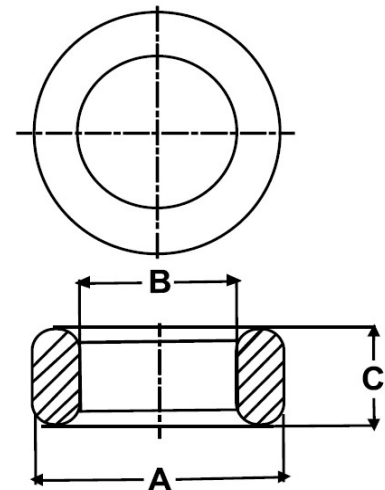

- Ferrite material for the product is in compliance with RoHS directive 2011/65/EU
- Epoxy Coating is UL Approved, UL file number E483791
- Coating material for the product is in compliance with RoHS directive 2011/65/EU

For general terms and conditions please visit

http://www.cosmoferrites.com/Downloads/Downloads/bcb70e7c-ae33-40ec-a881-0d5120db57b6_GTC.pdf**Regd. Office & Works: Jabli, Distt. Solan, Himachal Pradesh – 173 209 (India)****E-mail: sales@cosmoferrites.com**