

**PRODUCT DATA SHEET****Appearance & Shape:** To be free from any defect such as flow, burrs, unevenness etc; as per IEC standards**Effective parameters irrespective of material grade (per piece)**

Parameter	Value	Unit
Effective Length (L_e)	43.3	mm
Effective Area (A_e)	19	mm ²
Effective Area (A_{Min})	19	mm ²
Effective Volume (V_e)	823	mm ³
Approx. Weight (without gap)	4.6	g/piece

**T1806 Coated (Green)****Test Conditions:** 10kHz/150mV/CFR COIL,N=01/ L_0 =Zero/25°C

Material Grade	Initial Permeability (μ_{iac})	AL Value (nH)	D. Strength (kV)	Ordering code
CF195	5000 ±20%	2750 +30%/-20%	≥2.0	CF195 T1806 C
CF190	6000 ±20%	3300 +30%/-20%	≥2.0	CF190 T1806 C
CF197	7000 ±20%	3850 +30%/-20%	≥2.0	CF197 T1806 C
CF199	9000 ±20%	4950 +30%/-30%	≥2.0	CF199 T1806 C

Dimensions Un-Coated Core (in mm)

Dimension	Nominal	Maximum	Minimum
A	17.5	18.0	17.0
B	11.05	11.35	10.75
C	6.0	6.2	5.8

Dimensions Coated Core (in mm)

Dimension	Nominal	Maximum	Minimum
A	-	18.6	-
B	-	-	10.15
C	-	6.8	-

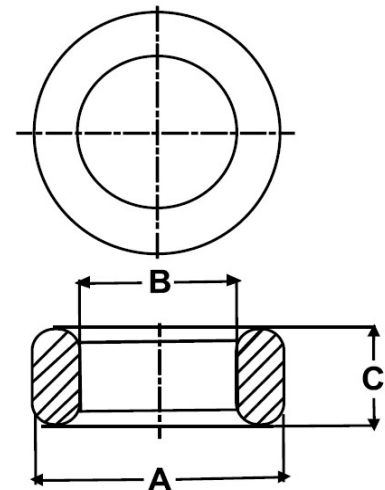

- Ferrite material for the product is in compliance with RoHS directive 2011/65/EU
- Epoxy Coating is UL Approved, UL file number E483791
- Coating material for the product is in compliance with RoHS directive 2011/65/EU

For general terms and conditions please visit

http://www.cosmoferrites.com/Downloads/Downloads/bcb70e7c-ae33-40ec-a881-0d5120db57b6_GTC.pdf**Regd. Office & Works: Jabli, Distt. Solan, Himachal Pradesh – 173 209 (India)****E-mail: sales@cosmoferrites.com**